

# IPC Accessories Installation Guide

2020-04-28

# Dome camera mount

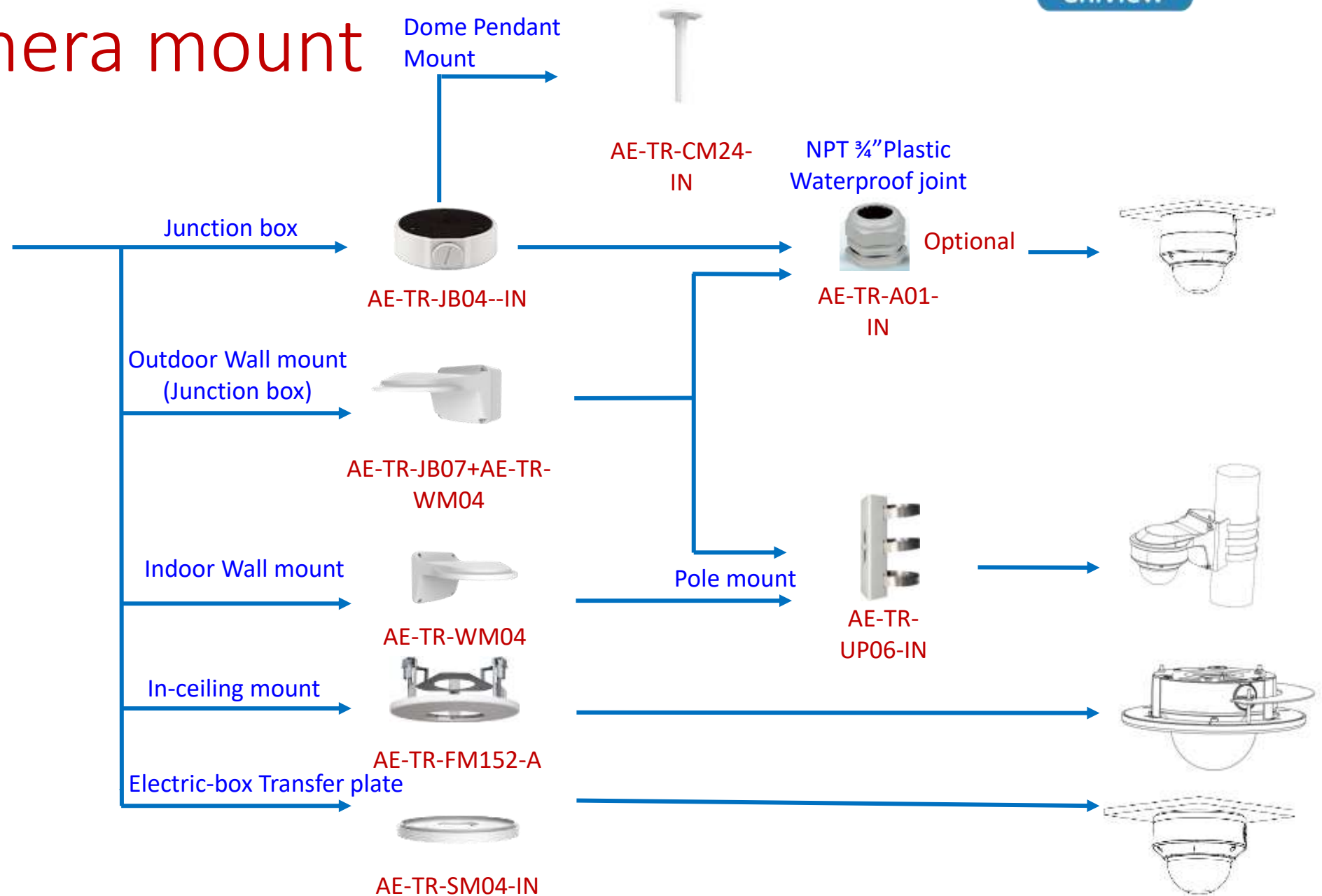

# Dome camera mount

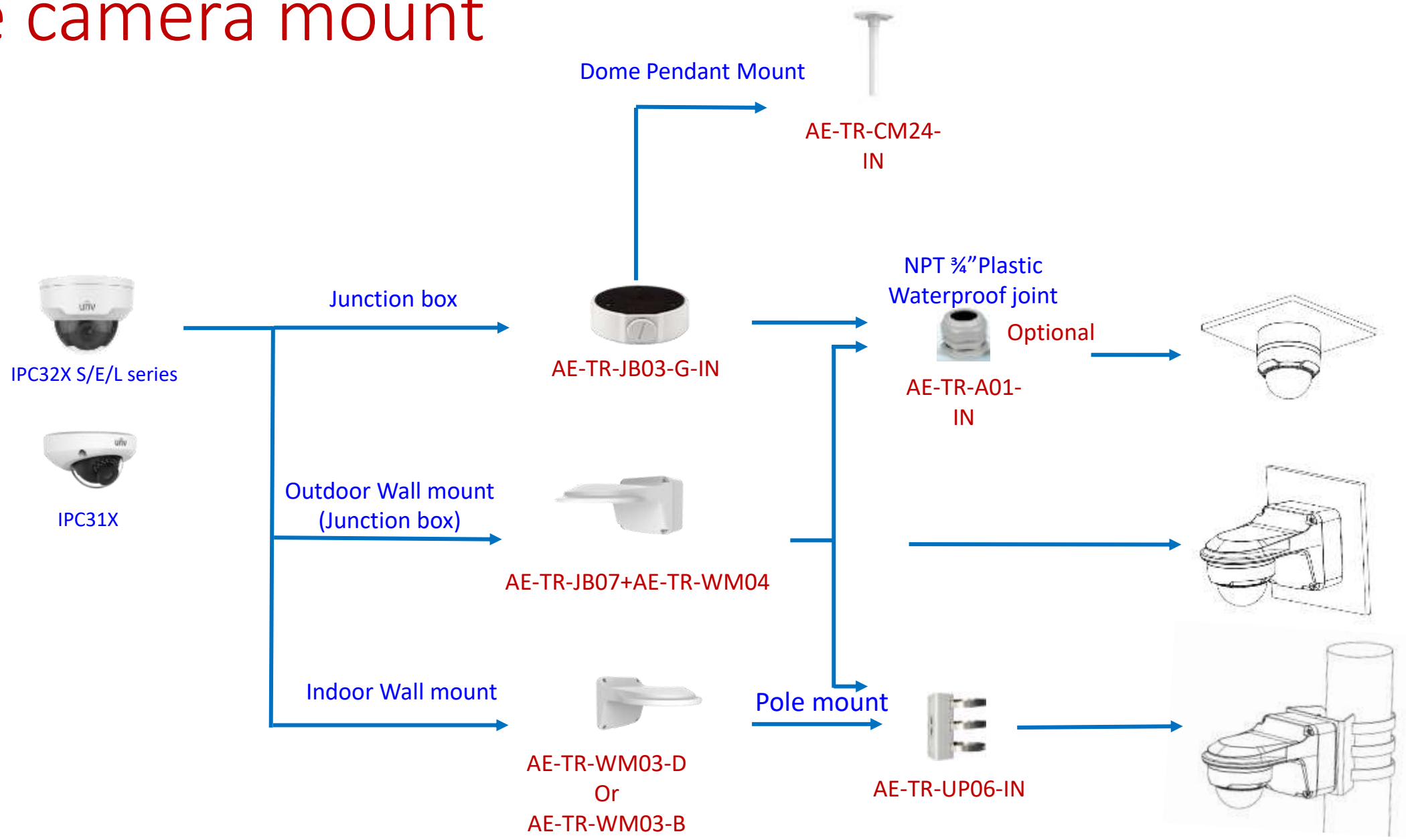

# Dome camera mount

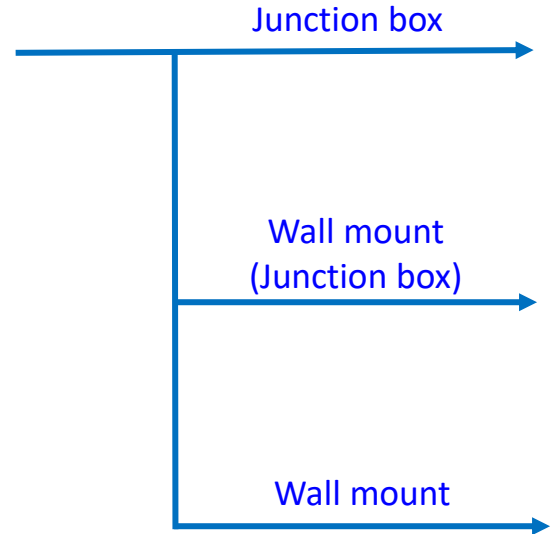

Dome Pendant Mount

AE-TR-CM24-IN



NPT 3/4" Plastic  
Waterproof joint



Optional

AE-TR-A01-IN



AE-TR-JB07+AE-TR-WM04



Pole mount

AE-TR-UP06-IN



# Fisheye camera mount

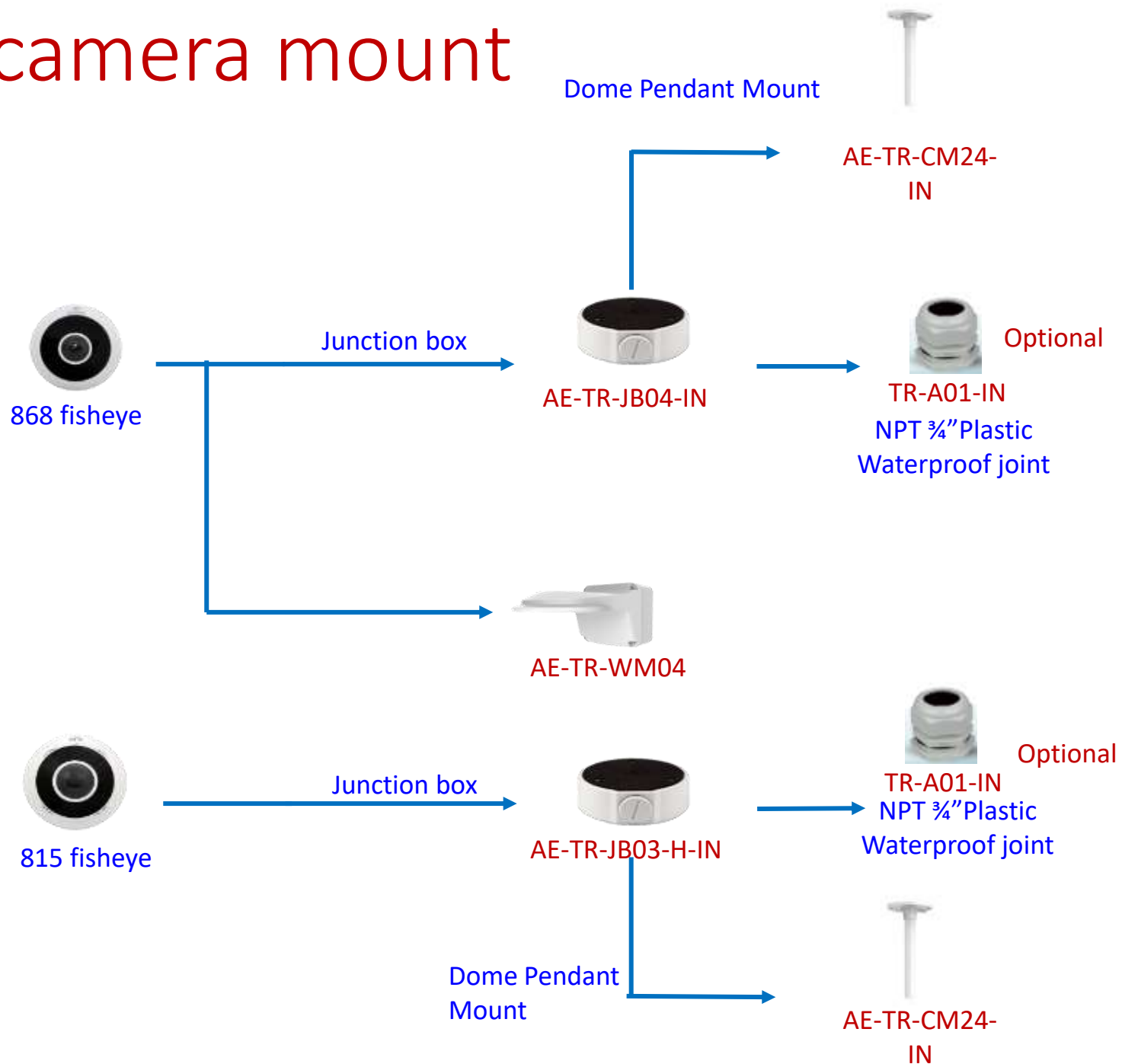

# Bullet camera mount



Junction box



Pole mount



NPT 3/4" Plastic Waterproof joint



Outdoor Pole mount



Recommended side outlet for cable



Optional



TR-A01-IN



AE-TR-UP06-IN

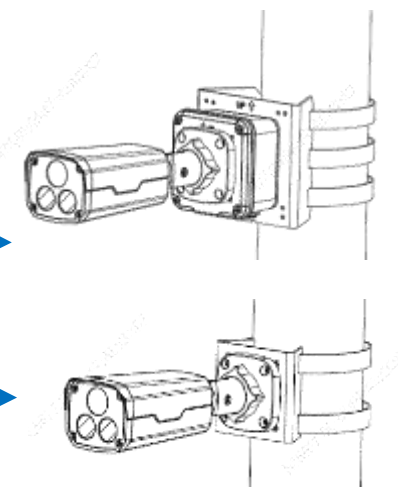

# Mini Bullet camera mount

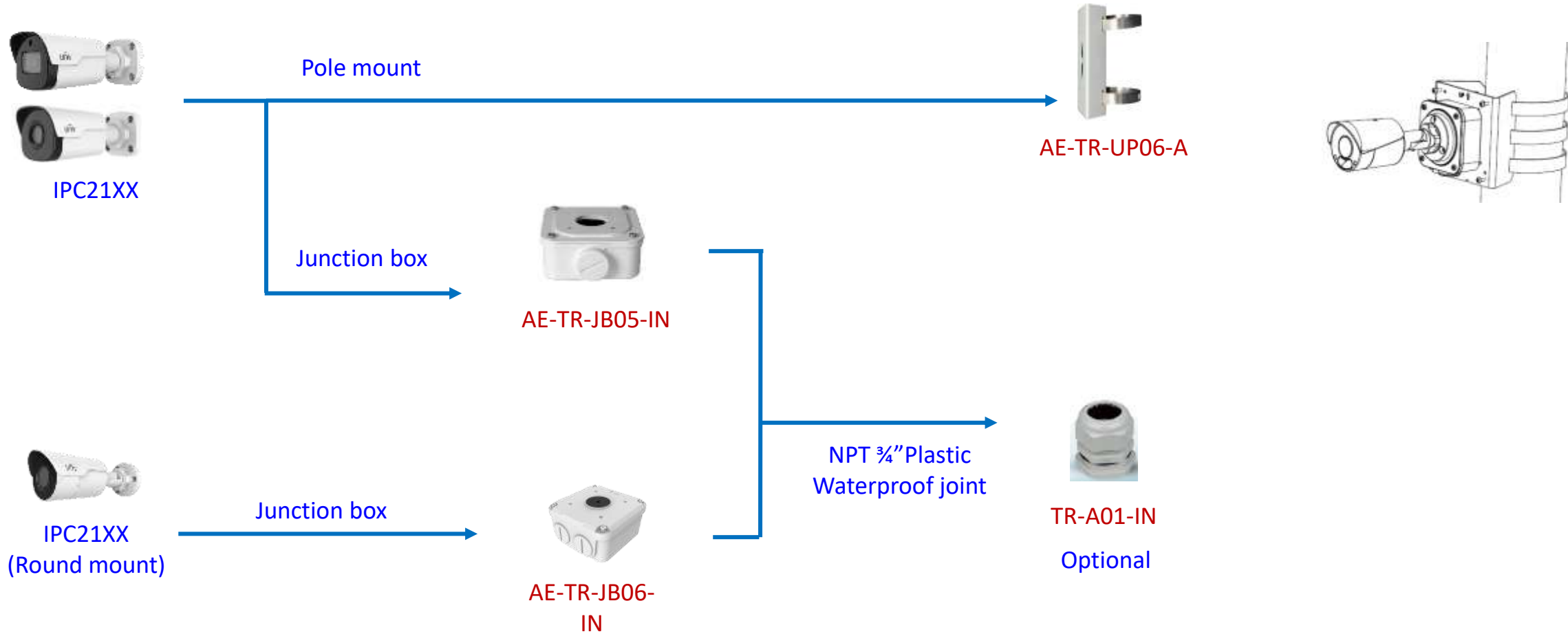

# Outdoor mini PTZ camera mount



IPC672 Series

Junction box  
→



AE-TR-JB07-IN

NPT 3/4" Plastic Waterproof joint  
→  
Pole mount  
→  
Recommended side outlet for cable

Optional



AE-TR-A01-IN



AE-TR-UP06-IN



# PTZ camera mount



IPC62xx Series  
IPC63xx Series

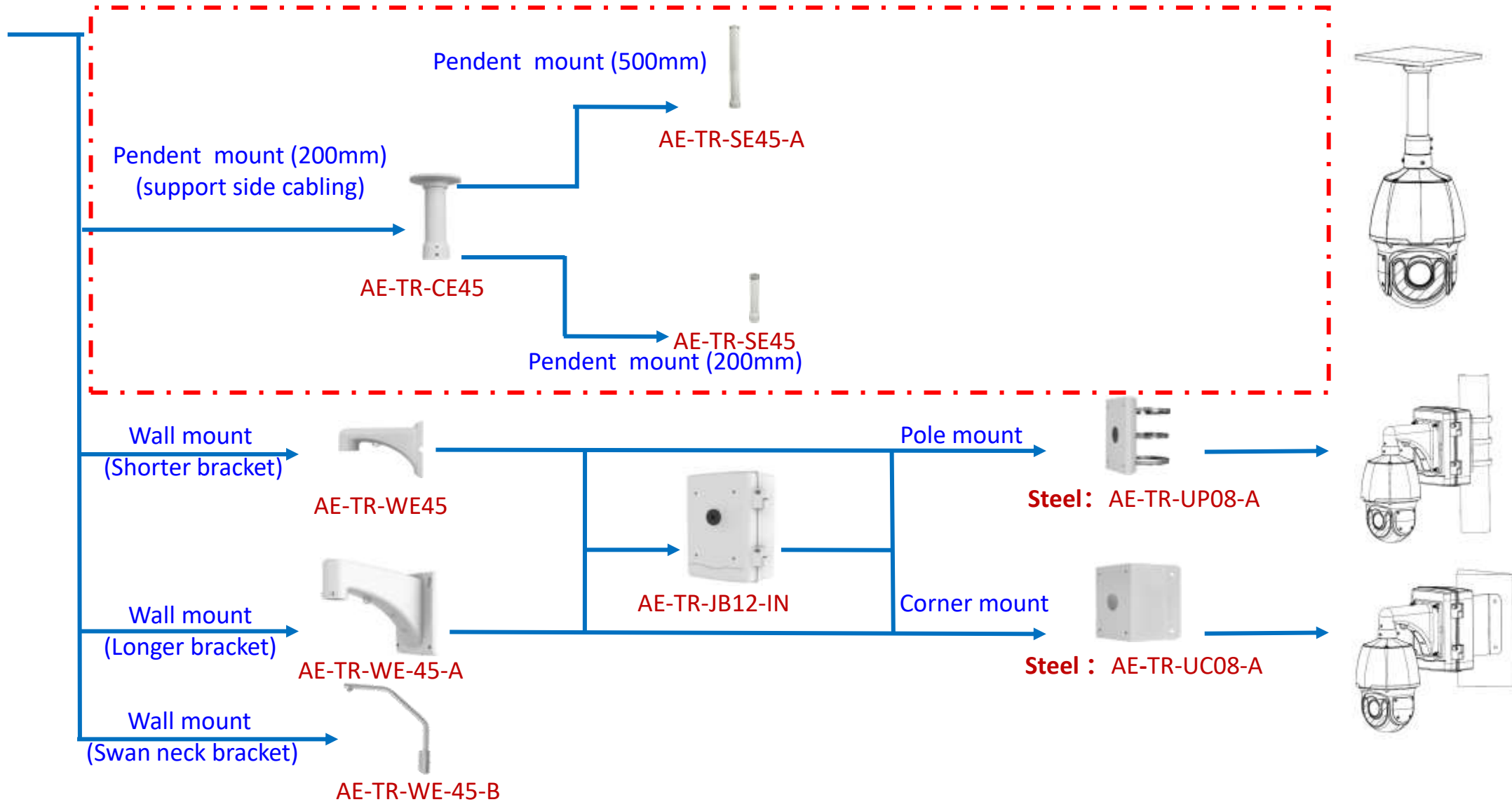

# PTZ camera mount

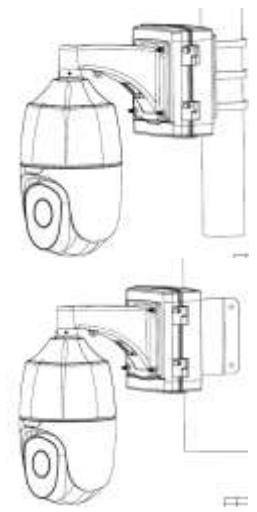
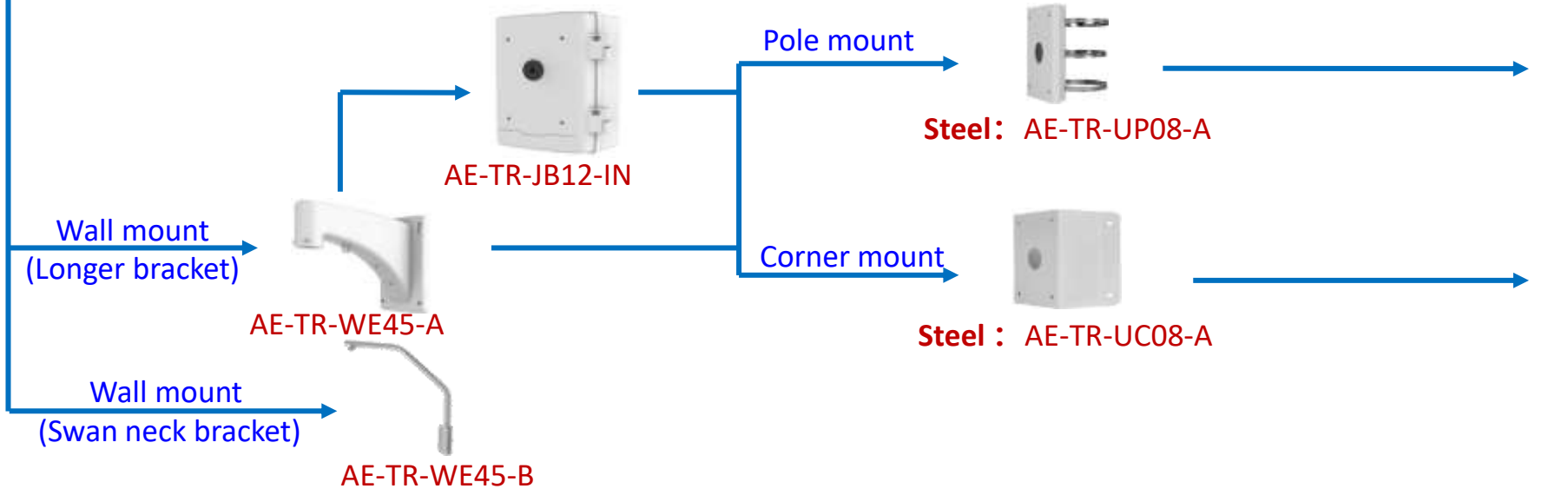
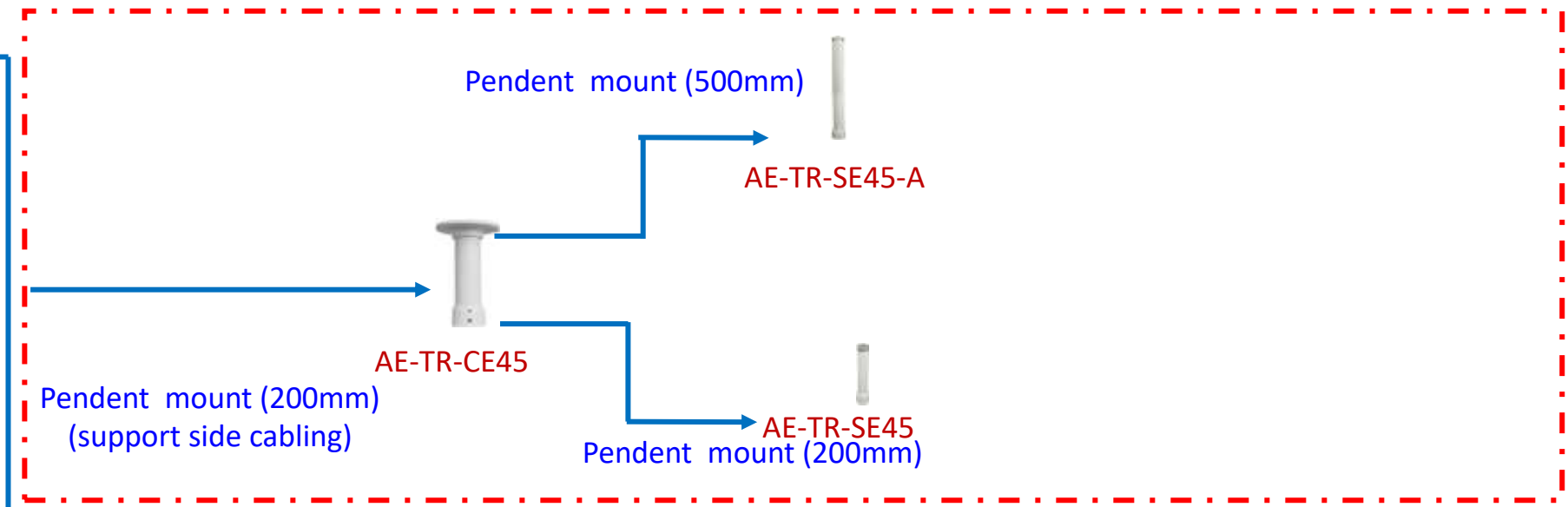

# Indoor PTZ camera mount



IPC6222EI-X22UP-C

In-ceiling mount



AE-TR-FM200-IN



# Indoor PTZ camera mount

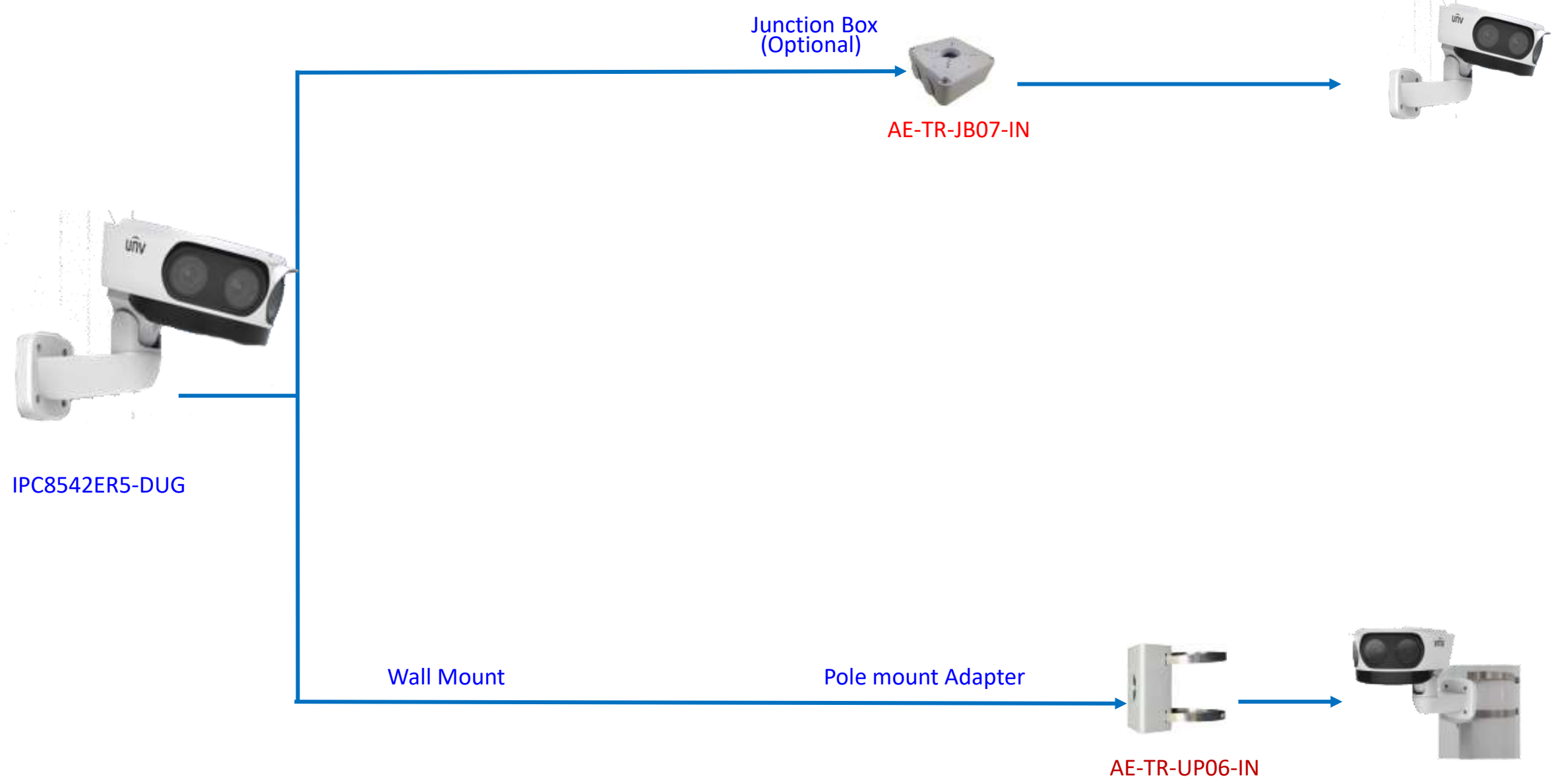

# Positioning system mount

IPC7622 Series



Pedestal installation

No accessory



It is necessary to ensure that the mounting base is firm enough

The logo for Uniview, featuring the word "uniview" in a white, lowercase, sans-serif font. A thin white line arches over the "i" and "v". The text is centered within a white graphic element that consists of a horizontal line with rounded ends, forming a shallow U-shape that frames the text from below and sides.

uniview